

plywood ■ lumber ■ veneer
PRODUCT GUIDE

2023

plyboo®



www.plyboo.com 866.835.9859



SMITH & FONG COMPANY, PLYBOO® PLYWOOD, VENEER AND LUMBER

APPLICATIONS:

- Ceilings and Walls
- Millwork
- Cabinetry
- Doors + Molding
- Furniture

INDOOR AIR QUALITY:

All products meet or surpass CARB II Indoor air quality requirements, confirmed through independent, 3-party testing using ASTM D6007/D5197 test methods

FIRE RATING:

All products meet a Class C rating
Class B available for most products, available upon request

SUSTAINABILITY:

FSC 100% is available on all products offered. We strive for the most sustainable materials in the industry.





LEED: Potential credits possible

Many LEED credits possible based
On our third party certifications



CERTIFICATIONS:

LCA/EPD
FSC
DECLARE
PHAROS



plyboo®

	Amber Edge Grain 3-ply, single-ply plywood, veneer, dimensional lumber	3-4
	Natural Edge Grain 3-ply, single-ply plywood, veneer, dimensional lumber	5-6
	Amber Flat Grain 3-ply, veneer, dimensional lumber	7
	Natural Flat Grain 3-ply, veneer, dimensional lumber	9

plyboo strand®

	Havana Strand 3-ply and dimensional lumber	10
	Neopolitan Strand 3-ply and dimensional lumber	11
	Sahara Strand 3-ply and dimensional lumber	12

durapalm®

	Sugar Flat Palm 3-ply, lumber, veneer	13
	Sugar Linear 3-ply, single-ply, veneer	13
	Sugar Deco Palm 3-ply, single-ply, veneer	14

AMBER EDGE GRAIN

	<p>3-Ply Plywood (Cross Core) *mm tolerance ± .5mm thickness</p>
<p>1" x 48" x 96" 25mm x 1219mm x 2438mm</p>	<p>BP-V0196A-ULEF BP-V0196A-ULEF/FSC</p>
<p>¾" x 48" x 120" 19mm x 1219mm x 3048mm</p>	<p>BP-V48120A-ULEF BP-V48120A-ULEF/FSC</p>
<p>¾" x 48" x 96" 19mm x 1219mm x 2438mm</p>	<p>BP-V4896A-ULEF BP-V4896A-ULEF/FSC * BP-V4896A-NAF/FSC</p>
<p>½" x 48" x 96" 13mm x 1219mm x 2438mm</p>	<p>BP-V1296A-ULEF BP-V1296A-ULEF/FSC</p>
<p>¼" x 48" x 96" 6mm x 1219mm x 2438mm</p>	<p>BP-V1496A-ULEF BP-V1496A-ULEF/FSC</p>
	<p>Single + Double Ply Plywood *mm tolerance ± .5mm thickness</p>
<p>1 ½" x 30" x 120" 38mm x 762mm x 3048mm</p>	<p>BP-S1530120VA-ULEF BP-S1530120VA-ULEF/FSC</p>
<p>1 ½" x 48" x 96" 38mm x 1219mm x 2438mm</p>	<p>S154896VA-ULEF S154896VA-ULEF/FSC</p>
<p>¾" x 48" x 96" 19mm x 1219mm x 2438mm</p>	<p>BP-S4896VA-ULEF BP-S4896VA-ULEF/FSC</p>

- All products available FSC 100%
- All products CARB II compatible
- All products class C, class B fire rated available

* BP-V4896A-NAF/FSC - 01350 Formaldehyde Free

AMBER EDGE GRAIN

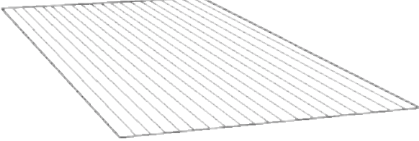
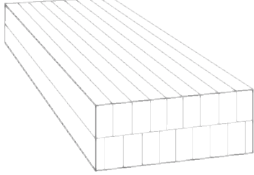
	<p>Veneer</p>
<p>2mm x 18" x 97" 2mm x 457mm x 2463mm</p>	<p>BVN-1897VA-ULEF/FSC (no back)</p>
<p>.6mm x 49" x 122" .6mm x 1245mm x 3099mm</p>	<p>BVN-48120VA-ULEF/FSC-Mixed (fleece back)</p>
<p>.6mm x 49" x 98" .6mm x 1245mm x 2490mm</p>	<p>BVN-4896VA-ULEF/FSC-Mixed (fleece back)</p>
<p>.6mm x 7/8" x 338' roll .6mm x 22mm x 100m</p>	<p>VNT-500VA-ULEF/FSC-Mixed (fleece back)</p>
	<p>Dimensional Lumber</p>
<p>Lengths - 2X2 (nominal) 96" (2438 mm) 120" (3048 mm) 96" (2438 mm) 120" (3048 mm)</p>	<p>DL-V2296A-ULEF DL-V22120A-ULEF DL-V2296A-ULEF/FSC DL-V22120A-ULEF/FSC</p>
<p>Lengths - 2X4 (nominal) 96" (2438 mm) 120" (3048 mm) 96" (2438 mm) 120" (3048 mm)</p>	<p>DL-V2496A-ULEF DL-V24120A-ULEF DL-V2496A-ULEF/FSC DL-V24120A-ULEF/FSC</p>
<p>Lengths - 2X6 (nominal) 96" (2438 mm) 120" (3048 mm) 96" (2438 mm) 120" (3048 mm)</p>	<p>DL-V2696A-ULEF DL-V26120A-ULEF DL-V2696A-ULEF/FSC DL-V26120A-ULEF/FSC</p>
<p>Lengths - 2X8 (nominal) 96" (2438 mm) 120" (3048 mm) 96" (2438 mm) 120" (3048 mm)</p>	<p>DL-V2896A-ULEF DL-V28120A-ULEF DL-V2896A-ULEF/FSC DL-V28120A-ULEF/FSC</p>

- All products available FSC 100%
- All products CARB II compatible
- All products class C

NATURAL EDGE GRAIN

	<p>3-Ply Plywood (Cross Core) *mm tolerance \pm .5mm thickness</p>
<p>1" x 48" x 96" 25mm x 1219mm x 2438mm*</p>	<p>BP-V0196N-ULEF BP-V0196N-ULEF/FSC</p>
<p>3/4" x 48" x 120" 19mm x 1219mm x 3048mm*</p>	<p>BP-V48120N-ULEF BP-V48120N-ULEF/FSC</p>
<p>3/4" x 48" x 96" 19mm x 1219mm x 2438mm*</p>	<p>BP-V4896N BP-V4896N-ULEF/FSC</p>
<p>1/2" x 48" x 96" 13mm x 1219mm x 2438mm*</p>	<p>BP-V1296N BP-V1296N-ULEF/FSC</p>
<p>1/4" x 48" x 96" 6mm x 1219mm x 2438mm*</p>	<p>BP-V1496N BP-V1496N-ULEF/FSC</p>
	<p>Single + Double Ply Plywood *mm tolerance \pm .5mm thickness</p>
<p>1 1/2" x 30" x 120" 38mm x 762mm x 3048mm*</p>	<p>BP-S1530120VN-ULEF BP-S1530120VN-ULEF/FSC</p>
<p>1 1/2" x 48" x 96" 38mm x 1219mm x 2438mm*</p>	<p>BP-S154896VN-ULEF BP-S154896VN-ULEF/FSC</p>
<p>3/4" x 48" x 96" 19mm x 1219mm x 2438mm*</p>	<p>BP-S4896VN-ULEF BP-S4896VN-ULEF/FSC</p>

- All products available FSC 100%
- All products CARB II compatible
- All products class C, class B fire rated available

NATURAL EDGE GRAIN

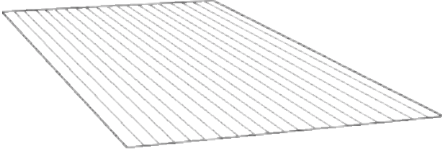
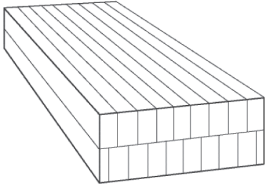
	<p>Veneer</p>
<p>2mm x 18" x 97" 2mm x 457mm x 2463mm</p>	<p>BVN-1897N-ULEF/FSC (no back)</p>
<p>.6mm x 49" x 122" .6mm x 1245mm x 3099mm</p>	<p>BVN-48120VN-ULEF/FSC-Mixed (fleece back)</p>
<p>.6mm x 49" x 98" .6mm x 1245mm x 2490mm</p>	<p>BVN-4896VN-ULEF/FSC-Mixed (fleece back)</p>
<p>.6mm x 7/8" x 338' roll .6mm x 22mm x 100m</p>	<p>VNT-500VN-ULEF/FSC-Mixed (fleece back)</p>
	<p>Dimensional Lumber</p>
<p>Lengths - 2X2 (nominal) 96" (2438mm) 120" (3048 mm) 96" (2438 mm) 120" (3048 mm)</p>	<p>DL-V2296N-ULEF DL-V22120N-ULEF DL-V2296N-ULEF/FSC DL-V22120N-ULEF/FSC</p>
<p>Lengths -2X4 (nominal) 96" (2438 mm) 120" (3048 mm) 96" (2438 mm) 120" (3048 mm)</p>	<p>DL-V2496N-ULEF DL-V24120N-ULEF DL-V2496N-ULEF/FSC DL-V24120N-ULEF/FSC</p>
<p>Lengths -2X6 (nominal) 96" (2438 mm) 120" (3048 mm) 96" (2438 mm) 120" (3048 mm)</p>	<p>DL-V2696N-ULEF DL-V26120N-ULEF DL-V2696N-ULEF/FSC DL-V26120N-ULEF/FSC</p>
<p>Lengths -2X8 (nominal) 96" (2438 mm) 120" (3048 mm) 96" (2438 mm) 120" (3048 mm)</p>	<p>DL-V2896N-ULEF DL-V28120N-ULEF DL-V2896N-ULEF/FSC DL-V28120N-ULEF/FSC</p>

- All products available FSC 100%
- All products CARB II compatible
- All products class C

AMBER FLAT® GRAIN

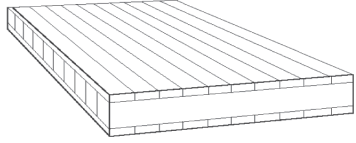
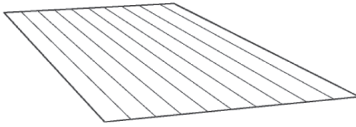
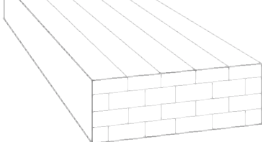
	<p>3-Ply Plywood (Cross Core) *mm tolerance ± .5mm thickness</p>
<p>1" x 48" x 96" 25mm x 1219mm x 2438mm*</p>	<p>BP-0196A-ULEF BP-0196A-ULEF/FSC</p>
<p>¾" x 48" x 120" 19mm x 1219mm x 3048mm*</p>	<p>BP-48120A-ULEF BP-48120A-ULEF/FSC</p>
<p>¾" x 48" x 96" 19mm x 1219mm x 2438mm*</p>	<p>BP-4896A-ULEF BP-4896A-ULEF/FSC</p>
<p>½" x 48" x 96" 13mm x 1219mm x 2438mm*</p>	<p>BP-1296A -ULEF BP-1296A-ULEF/FSC</p>
<p>¼" x 48" x 96" 6mm x 1219mm x 2438mm*</p>	<p>BP-1496A-ULEF BP-1496A-ULEF/FSC</p>
	<p>Veneer</p>
<p>2mm x 18" x 97" 2mm x 457mm x 2463mm</p>	<p>BHN-1897A-ULEF/FSC (no back)</p>
<p>6mm x 49" x 122" .6mm x 1245mm x 3099mm</p>	<p>BHN-48120A-ULEF/FSC-Mixed (fleece back)</p>
<p>.6mm x 49" x 98" .6mm x 1245mm x 2498mm</p>	<p>BHN-4896A-ULEF/FSC-Mixed (fleece back)</p>
<p>.6mm x 7/8" x 338' roll .6mm x 22mm x 100m</p>	<p>VNT-500A-ULEF/FSC-Mixed (fleece back)</p>
	<p>Dimensional Lumber *mm tolerance ± .5mm thickness</p>
<p>Lengths - 2X2 (nominal) 96" (2438mm) 120" (3048 mm) 96" (2438 mm) 120" (3048 mm)</p>	<p>DL-2296A-ULEF DL-22120A-ULEF DL-2296A-ULEF/FSC DL-22120A-ULEF/FSC</p>
<p>Lengths -2X4 (nominal) 96" (2438 mm) 120" (3048 mm) 96" (2438 mm) 120" (3048 mm)</p>	<p>DL-2496A-ULEF DL-24120A-ULEF DL-2496A-ULEF/FSC DL-24120A-ULEF/FSC</p>
<p>Lengths -2X6 (nominal) 96" (2438 mm) 120" (3048 mm) 96" (2438 mm) 120" (3048 mm)</p>	<p>DL-2696A-ULEF DL-26120A-ULEF DL-2696A-ULEF/FSC DL-26120A-ULEF/FSC</p>
<p>Lengths -2X8 (nominal) 96" (2438 mm) 120" (3048 mm) 96" (2438 mm) 120" (3048 mm)</p>	<p>DL-2896A-ULEF DL-28120A-ULEF DL-2896A-ULEF/FSC DL-28120A-ULEF/FSC</p>

- All products available FSC 100%
- All products CARB II compatible
- All products class C, class B fire rated available for 3-ply

NATURAL FLAT GRAIN

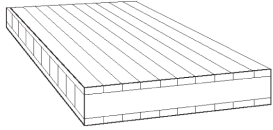
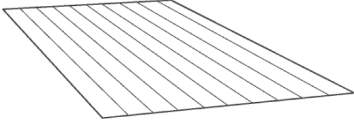
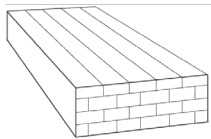
	<h2 style="color: red;">3-Ply Plywood</h2> <p>(Cross Core) *mm tolerance ± .5mm thickness</p>
<p>1" x 48" x 96" 25mm x 1219mm x 2438mm*</p>	<p>BP-0196N-ULEF BP-0196N-ULEF/FSC</p>
<p>¾" x 48" x 120" 19mm x 1219mm x 3048mm*</p>	<p>BP-48120N-ULEF BP-48120N-ULEF/FSC</p>
<p>¾" x 48" x 96" 19mm x 1219mm x 2438mm*</p>	<p>BP-4896N-ULEF BP-4896N-ULEF/FSC</p>
<p>½" x 48" x 96" 13mm x 1219mm x 2438mm*</p>	<p>BP-1296N-ULEF BP-1296N-ULEF/FSC</p>
<p>¼" x 48" x 96" 6mm x 1219mm x 2438mm*</p>	<p>BP-1496N-ULEF BP-1496N-ULEF/FSC</p>
	<h2 style="color: red;">Veneer</h2>
<p>2mm x 18" x 97" 2mm x 457mm x 2463mm</p>	<p>BHN-1897N-ULEF/FSC (no back)</p>
<p>6mm x 49" x 122" 6mm x 1245mm x 3099mm</p>	<p>BHN-48120N-ULEF/FSC-Mixed (fleece back)</p>
<p>.6mm x 49" x 98" 6mm x 1245mm x 2498mm</p>	<p>BHN-4896N-ULEF/FSC-Mixed (fleece back)</p>
<p>.6mm x 7/8" x 338' roll .6mm x 22mm x 100m</p>	<p>VNT-500N-FSC-Mixed (fleece back)</p>
	<h2 style="color: red;">Dimensional Lumber</h2>
<p>Lengths - 2X2 (nominal) 96" (2438mm) 120" (3048 mm) 96" (2438 mm) 120" (3048 mm)</p>	<p>DL-2296N-ULEF DL-22120N-ULEF DL-2296N-ULEF/FSC DL-22120N-ULEF/FSC</p>
<p>Lengths - 2X4 (nominal) 96" (2438 mm) 120" (3048 mm) 96" (2438 mm) 120" (3048 mm)</p>	<p>DL-2496N-ULEF DL-24120N-ULEF DL-2496N-ULEF/FSC DL-24120N-ULEF/FSC</p>
<p>Lengths - 2X6 (nominal) 96" (2438 mm) 120" (3048 mm) 96" (2438 mm) 120" (3048 mm)</p>	<p>DL-2696N-ULEF DL-26120N-ULEF DL-2696N-ULEF/FSC DL-26120N-ULEF/FSC</p>
<p>Lengths - 2X8 (nominal) 96" (2438 mm) 120" (3048 mm) 96" (2438 mm) 120" (3048 mm)</p>	<p>DL-2896N-ULEF DL-28120N-ULEF DL-2896N-ULEF/FSC DL-28120N-ULEF/FSC</p>

- All products available FSC 100%
- All products CARB II compatible
- All products class C, class B fire rated available for 3-ply

HAVANA® STRAND

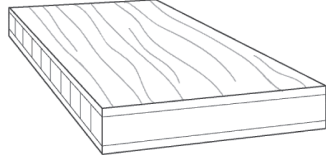
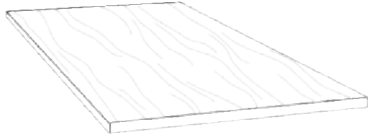
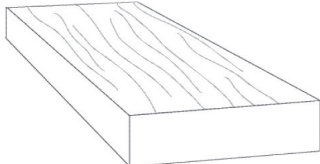
	<p>3-Ply Plywood (Cross Core) *mm tolerance ± .5mm thickness</p>
<p>¾" x 48" x 96" 19mm x 1219mm x 2438mm*</p>	<p>BP-4896PD-ULEF BP-4896PD-ULEF/FSC</p>
<p>¾" x 48" x 72" 19mm x 1219mm x 1830mm*</p>	<p>BP-4872PD-ULEF BP-4872PD-ULEF/FSC</p>
	<p>Edge Banding</p>
<p>4mm x 18" x 96" 4mm x 762mm x 2438mm</p>	<p>BP-1896PD-ULEF/FSC (no back)</p>
	<p>Dimensional Lumber</p>
<p>Lengths - 2X2 (nominal) 72" (1830 mm)</p>	<p>DL-2272PD-NAUF/FSC</p>
<p>Lengths - 2X4 (nominal) 72" (1830 mm)</p>	<p>DL-2472PD-NAUF/FSC</p>
<p>Lengths - 2X6 (nominal) 72" (1830 mm)</p>	<p>DL-2672PD-NAUF/FSC</p>
<p>Lengths - 2X8 (nominal) 72" (1830 mm)</p>	<p>DL-2872PD-NAUF/FSC</p>

- All products available FSC 100%
- All products CARB II compatible
- All products class C, class B fire rated available for 3-ply
- Dimensional Lumber is NAUF (No added urea formaldehyde)

NEOPOLITAN® STRAND

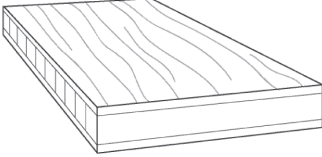
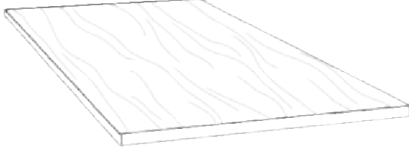
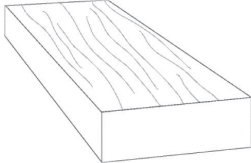
	<p>3-Ply Plywood</p> <p>(Cross Core) *mm tolerance ± .5mm thickness</p>
<p>¾" x 48" x 96" 19mm x 1219mm x 2438mm*</p>	<p>BP-4896NEO-ULEF BP-4896NEO-ULEF/FSC</p>
<p>¾" x 48" x 72" 19mm x 1219mm x 1830mm*</p>	<p>BP-4872NEO-ULEF BP-4872NEO-ULEF/FSC</p>
	<p>Edge Banding</p>
<p>4mm x 18" x 96" 4mm x 762mm x 1830mm</p>	<p>BP-1896NEO-ULEF/FSC (no back)</p>
	<p>Dimensional Lumber</p>
<p>Lengths - 2X2 (nominal) 72" (1830 mm)</p>	<p>DL-2272NEO-NAUF/FSC</p>
<p>Lengths - 2X4 (nominal) 72" (1830 mm)</p>	<p>DL-2472NEO-NAUF/FSC</p>
<p>Lengths - 2X6 (nominal) 72" (1830 mm)</p>	<p>DL-2672NEO-NAUF/FSC</p>
<p>Lengths - 2X8 (nominal) 72" (1830 mm)</p>	<p>DL-2872NEO-NAUF/FSC</p>

- All products available FSC 100%
- All products CARB II compatible
- All products class C, class B fire rated available for 3-ply
- Dimensional Lumber is NAUF (No added urea formaldehyde)

SAHARA® STRAND

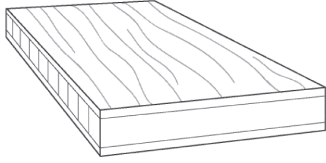
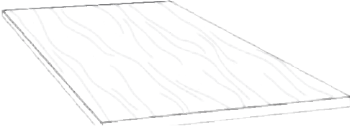
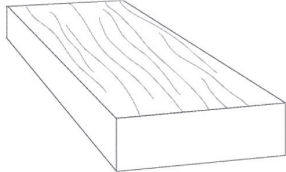
	<p>3-Ply Plywood (Cross Core) *mm tolerance ± .5mm thickness</p>
<p>¾" x 48" x 96" 19mm x 1219mm x 2438mm*</p>	<p>BP-4896PH-ULEF BP-4896PH-ULEF/FSC</p>
<p>¾" x 48" x 72" 19mm x 1219mm x 1830mm*</p>	<p>BP-4872PH-ULEF BP-4872PH-ULEF/FSC</p>
	<p>Edge Banding</p>
<p>4mm x 30" x 96" 4mm x 762mm x 2438mm</p>	<p>BP-1896PH-ULEF/FSC (no back)</p>
	<p>Dimensional Lumber</p>
<p>Lengths - 2X2 (nominal) 72" (1830 mm)</p>	<p>DL-2272PH-ULEF/FSC</p>
<p>Lengths - 2X4 (nominal) 72" (1830 mm)</p>	<p>DL-2472PH-ULEF/FSC</p>
<p>Lengths - 2X6 (nominal) 72" (1830 mm)</p>	<p>DL-2672PH-ULEF/FSC</p>
<p>Lengths - 2X8 (nominal) 72" (1830 mm)</p>	<p>DL-2872PH-NAUF/FSC</p>

- All products available FSC 100%
- All products CARB II compatible
- All products class C, class B fire rated available for 3-ply
- Dimensional Lumber is NAUF (No added urea formaldehyde)

SUGAR FLAT PALM

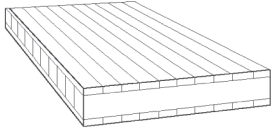
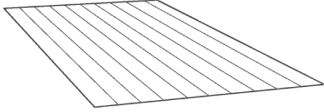
	3-Ply Plywood (Cross Core) *mm tolerance ± .5mm thickness
3/4" x 48" x 72" 19mm x 1219 x 1830mm	PB-4872SG-ULEF
3/4" x 48" x 48" 19mm x 1219 x 1219mm	PB-4848SFSG-ULEF
1/2" x 48" x 72" 13mm x 1219 x 1830mm	PB-1272SG-ULEF
	Veneer
1mm x 3.5" x various lengths 1mm x 88mm x various lengths	BPN-135SG-ULEF
.8mm x 49" x 49" .8mm x 1245mm x 1245mm	BPN-4848SG-ULEF

SUGAR LINEAR PALM

	3-Ply Plywood
3/4" x 48" x 96" 19mm x 1219mm x 2438mm	PB-V4896SG-ULEF
3/4" x 48" x 72" 19mm x 1219mm x 1830mm	PB-V4872SG-ULEF
1/2" x 48" x 72" 13mm x 1219mm x 1830mm	PB-V1272SG-ULEF
	Single-Ply Plywood
3/4" x 14.2" x 48" 19mm x 360mm x 1219mm	PB-S1448VSG-ULEF
	Veneer
2mm x 5" x 72" 2mm x 127mm x 1830mm	BPN-V272SG-ULEF

SUGAR DECO PALM

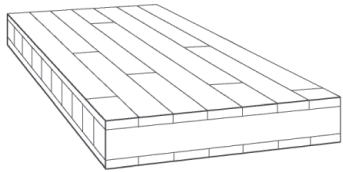
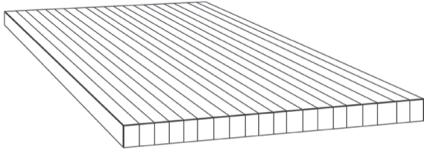
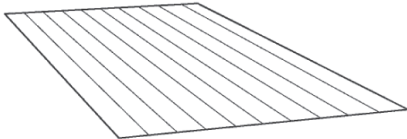
	<p>3-Ply Plywood (Cross Core) *mm tolerance ± .5mm thickness</p>
<p>¾" x 48" x 96" 19mm x 1219 x 2438mm*</p>	<p>PB-DC4896UPN-SG-ULEF</p>
	<p>Single-Ply Plywood</p>
<p>¾" x 14.2" x 96" 19mm x 360mm x 2438mm</p>	<p>PB-S1496DSG-ULEF</p>
	<p>Veneer</p>
<p>2mm x 12" x 96" 2mm x 305mm x 2438mm</p>	<p>BPN-DC1297UPN-SG-ULEF</p>

- All Durapalm® Products listed here are CARB II compatible
- All Durapalm® Products Standard class C
- Durapalm® Dimensional Lumber is, NAF (no added urea formaldehyde)



smith+fong company
394 bel marin keys blvd #6
novato, ca 94949
866.835.9859

plyboo®

VOL / 012023